

Features

- Nominal voltage : 220-240V AC, 50/60 Hz
- Input voltage range : 198-264V AC
- Protection class : II
- IP44 (with IP20 remote power supply) or IP65 (depending on version)
- IK10 / 20 joules (standard version)
- VK21 as ceiling fitting (standard version)
- IK11 / 50 joules (vandal-resistant version)
- VK32 as ceiling fitting (vandal-resistant version)
- Incandescent wire 850° / 30 s
- Rated ambient operating temperature : 25° C
- Operating temperature range : -20 °C ... +35 °C
- IRC : 80
- SDCM : 3
- Photobiological hazard : RG0
- Energy class C light source
- Lumen maintenance : L80B10 / supérieur à 72 000 h
- Number of detector switching cycles: 1,000,000 at maximum load.
- Repairable luminaire. Spare parts available on demand
- 5-year guarantee, details of conditions available on securlite.com

Detection characteristics

- PRO detection version (*built-in*): ON/OFF or Extinction warning or Standby mode adjustable using remote control **98000010** (see guide [NOT0445](#))

Microwave detection: 5.8 GHz
Microwave power: 5 mW typical

Presets under standard conditions of use:

Field sensitivity at 50% (Ø 4 m)
Timer at 1 min
Ambient light 50 lux typical
Extinction warning mode ON

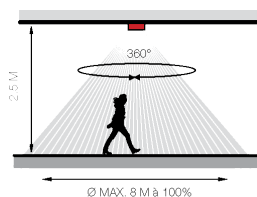

- Slave version: ON/OFF or Extinction warning or Standby mode adjustable using remote control 98000010 (with master/slave daisy-chaining: up to 20 luminaires max – see guide [NOT0445](#)).

Applications

- Architectural luminaire for indoor (IP44) or outdoor (IP65) environments subject to only minor vandalism
- Conditions of use:
 - Models with detection: suitable for indoor use
 - Installation positions: refer to installation instructions

Technical and dimensional data are given for information only and may be modified at any time without notice. Please enquire before ordering.

Materials

- Bezel and body: painted zamak (marine environment resistant)
- Diffuser: clear polycarbonate
- Reflector: white polycarbonate
- Remote power supply within suspended ceiling, with 30 cm cable
- RoHS: the products contain no prohibited substances as defined in the European Directive 2011/65/UE and amendments

Colours / Finish

- Standard bezel colour: white RAL9016 polyester paint (other ring colours on request)

Fixings

- Luminaire: using 4 TORX type screws, not visible from the front
- Vandal-resistant version: luminaire fixed using 2 steel TORX type screws on the front

Accessories

(to be ordered separately)

- M5 bit for security Torx screws – **code: 98000012** (vandal-resistant version)
- Bit-holder M5 – **code: 98000005**
- Remote control (radio-control version) – **code: 98000010**
- Square adaptor kit for replacing old Sécurlite downlight with a Senspot – **code: 98403003**
- Round adaptor kit for replacing old Sécurlite downlight with a Senspot – **code: 98403004**
- Back box for use in concrete - Senspot IP44 – **code: 98403002**
- Back box for use in concrete - Senspot IP65 – **code: 98403001**

Approvals

Certificates available:

- CE certificate (as per EN60598-1 / 2-2)
- Incandescent Wire Test certificate (depending on product)

Dimensions

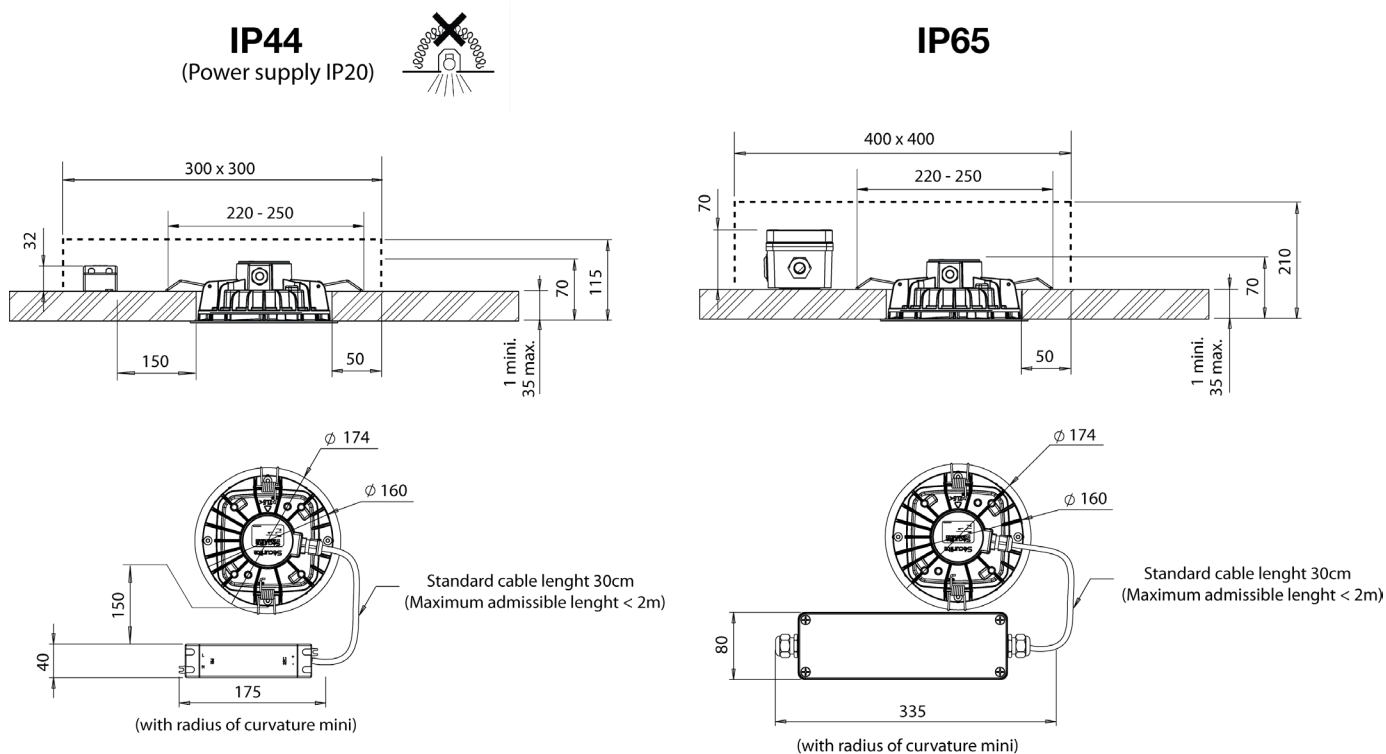

Technical and dimensional data are given for information only and may be modified at any time without notice. Please enquire before ordering.

Fixation

- Luminaire fixed by pressure spring or by steel screws on the front (vandal-resistant version)



IP44 A : 33 mm
IP65 A : 70 mm

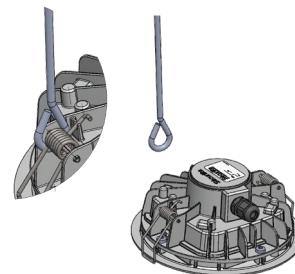
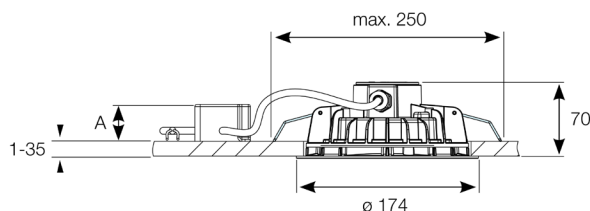

Wiring

- IP44 version: Connection to the remote power supply
- IP65 version: Connection to remote power supply within sealed connection box with cable gland

43 PRO detection and 03 slave versions wiring

Wired version (Master / Slave) :

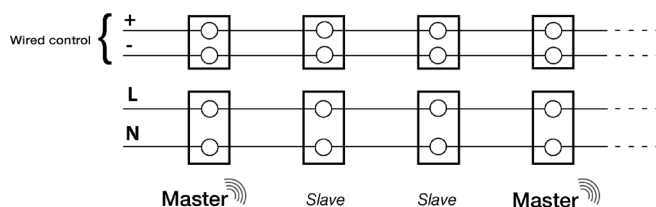

Wired version (Master or Slave) external control :

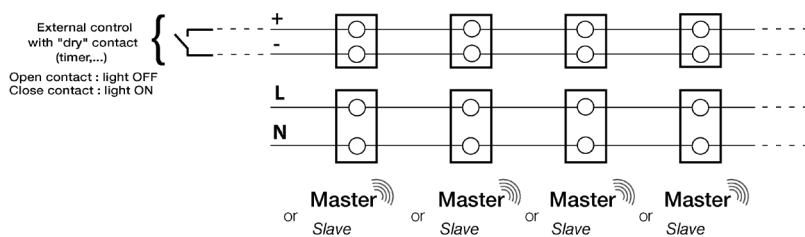

Remote version (Master / Slave) :

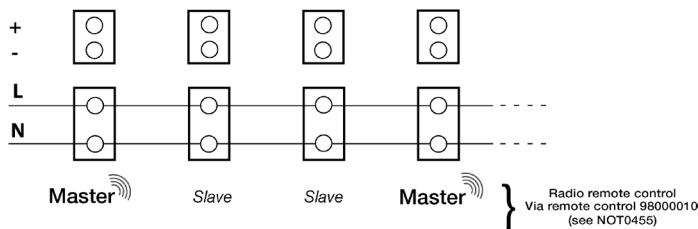

Technical and dimensional data are given for information only and may be modified at any time without notice. Please enquire before ordering. 3

Technical data and order codes

Standard version – PRO Detection (integrated) :

ON/OFF or Extinction warning or Standby mode adjustable by remote control, master / slave daisy-chaining.

SENSPOT IP44 - pressure spring version								
Designation	CCT (K)	Power (W)	Luminaire Output (lm)	Luminaire efficacy (lm/W)	Weight (Kg)	White	Grey	Black
Senspot 1700	3000	13	1247	95,9	1,6	40350343	40353343	40352343
Senspot 1700	4000	13	1300	100	1,6	40350443	40353443	40352443
Senspot 2200	3000	17	1564	92	1,6	40360343	40363343	40362343
Senspot 2200	4000	17	1630	95,9	1,6	40360443	40363443	40362443

SENSPOT IP65 - pressure spring version								
Designation	CCT (K)	Power (W)	Luminaire Output (lm)	Luminaire efficacy (lm/W)	Weight (Kg)	White	Grey	Black
Senspot 1700	3000	13	1247	95,9	2,15	40300343	40303343	40302343
Senspot 1700	4000	13	1300	100	2,15	40300443	40303443	40302443
Senspot 2200	3000	17	1564	92	2,15	40310343	40313343	40312343
Senspot 2200	4000	17	1630	95,9	2,15	40310443	40313443	40312443

Standard version - Slave :

ON/OFF or Extinction warning or Standby mode adjustable by remote control, daisy-chained to PRO detection version.

SENSPOT IP44 - pressure spring version								
technical specifications and conditions of use : www.securlite.com (NOT0880)								
Designation	CCT (K)	Power (W)	Luminaire Output (lm)	Luminaire efficacy (lm/W)	Weight (Kg)	White	Grey	Black
Senspot 1700	3000	12	1247	103,9	1,6	40350303	40353303	40352303
Senspot 1700	4000	12	1300	108,3	1,6	40350403	40353403	40352403
Senspot 2200	3000	16	1564	97,8	1,6	40360303	40363303	40362303
Senspot 2200	4000	16	1630	101,9	1,6	40360403	40363403	40362403

SENSPOT IP65 - pressure spring version								
technical specifications and conditions of use : www.securlite.com (NOT0880)								
Designation	CCT (K)	Power (W)	Luminaire Output (lm)	Luminaire efficacy (lm/W)	Weight (Kg)	White	Grey	Black
Senspot 1700	3000	12	1247	103,9	2,15	40300303	40303303	40302303
Senspot 1700	4000	12	1300	108,3	2,15	40300403	40303403	40302403
Senspot 2200	3000	16	1564	97,8	2,15	40310303	40313303	40312303
Senspot 2200	4000	16	1630	101,9	2,15	40310403	40313403	40312403

Operating instruction : www.securlite.com (NOT0735)

Technical and dimensional data are given for information only and may be modified at any time without notice. Please enquire before ordering.

Technical data and order codes

Vandal-resistant version – PRO Detection (integrated) :

ON/OFF or Extinction warning or Standby mode adjustable by remote control, master / slave daisy-chaining.

SENSPOT IP44 – vandal-resistant version								
Designation	CCT (K)	Power (W)	Luminaire Output (lm)	Luminaire efficacy (lm/W)	Weight (Kg)	White	Grey	Black
Senspot 1700	3000	13	1247	95,9	1,6	40450343	40453343	40452343
Senspot 1700	4000	13	1300	100	1,6	40450443	40453443	40452443
Senspot 2200	3000	17	1564	92	1,6	40460343	40463343	40462343
Senspot 2200	4000	17	1630	95,9	1,6	40460443	40463443	40462443

SENSPOT IP65 – vandal-resistant version								
Designation	CCT (K)	Power (W)	Luminaire Output (lm)	Luminaire efficacy (lm/W)	Weight (Kg)	White	Grey	Black
Senspot 1700	3000	13	1247	95,9	2,15	40400343	40403343	40402343
Senspot 1700	4000	13	1300	100	2,15	40400443	40403443	40402443
Senspot 2200	3000	17	1564	92	2,15	40410343	40413343	40412343
Senspot 2200	4000	17	1630	95,9	2,15	40410443	40413443	40412443

Vandal-resistant version - Slave :

ON/OFF or Extinction warning or Standby mode adjustable by remote control, daisy-chained to PRO detection version.

SENSPOT IP44 – vandal-resistant version - Dali switch dimming								
technical specifications and conditions of use : www.securlite.com (NOT0880)								
Designation	CCT (K)	Power (W)	Luminaire Output (lm)	Luminaire efficacy (lm/W)	Weight (Kg)	White	Grey	Black
Senspot 1700	3000	13	1247	95,9	1,6	40450303	40453303	40452303
Senspot 1700	4000	13	1300	100	1,6	40450403	40453403	40452403
Senspot 2200	3000	17	1564	92	1,6	40460303	40463303	40462303
Senspot 2200	4000	17	1630	95,9	1,6	40460403	40463403	40462403

SENSPOT IP65 – vandal-resistant version - Dali switch dimming								
technical specifications and conditions of use : www.securlite.com (NOT0880)								
Designation	CCT (K)	Power (W)	Luminaire Output (lm)	Luminaire efficacy (lm/W)	Weight (Kg)	White	Grey	Black
Senspot 1700	3000	13	1247	95,9	2,15	40400303	40403303	40402303
Senspot 1700	4000	13	1300	100	2,15	40400403	40403403	40402403
Senspot 2200	3000	17	1564	92	2,15	40410303	40413303	40412303
Senspot 2200	4000	17	1630	95,9	2,15	40410403	40413403	40412403

Operating instruction : www.securlite.com (NOT0735)

Technical and dimensional data are given for information only and may be modified at any time without notice. Please enquire before ordering.