



**SÉCURLITE**  
DURABLE LIGHT

DESIGNED AND MADE IN FRANCE  
SINCE 1986

# TRANSPORT





## AN ETHICAL AND SOCIAL COMMITMENT

Based on human values and team spirit, our company, a human-sized SME, part of RIVALEN Family Group, relies on the professionalism of its employees, their skills and their enthusiasm to create the innovations of tomorrow.



## AN ENVIRONMENTAL INNOVATION

To move towards a circular economy, Securlite is constantly improving the analysis of the life cycle of luminaires, both in terms of energy impact and recyclability. For example, by incorporating recycled polycarbonates in its products and by designing disconnectable and repairable equipment.



## 5 YEARS GUARANTEE AS A STANDARD

Securlite luminaires are made from the most efficient materials and most up to date components, according to strong manufacturing requirements and high quality criteria.



## QUALITY APPROACH

Since 2015, Securlite has been part of a continuous improvement process and ISO 9001 certification structures all of our activities. It is also a guarantee of quality for our organization and our products.



## FULLY REPAIRABLE LUMINAIRES

Our luminaires have been studied and designed to propose longer and improved lifespan. For this reason that they are completely disconnectable, and the components are interchangeable. In the event of a possible malfunction, our after-sales service quickly collects, repairs and returns the luminaires.



## A CERTIFIED FRENCH PRODUCTION

Involved in the dynamization of the economic life of our territory, we have chosen to design and manufacture most of our products in France and to favor local suppliers and subcontractors. Integrated production: electronics and mechanics, an engineering hub (engineering expertise centre), laboratory + design office for adaptation and made-to-measure.

# OUR COMMITMENTS

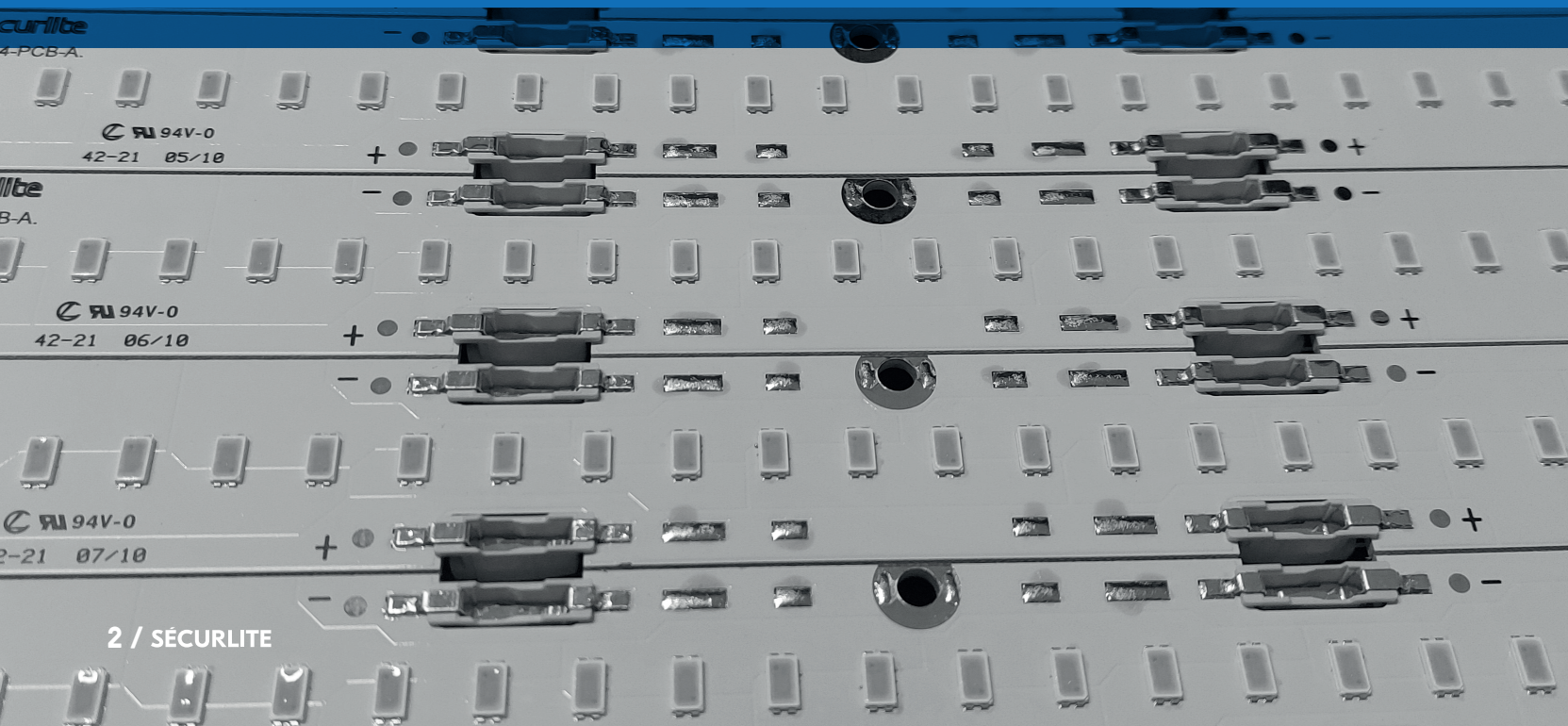

## A LIGHTING SOLUTION FOR ALL APPLICATION



In order to guarantee the right lighting level and visual comfort, our lighting studies are carried out according to standard **EN 12464-1: 2021** by our internal design office.

## MECHANICAL AND ELECTRONIC DESIGN DEPARTMENT

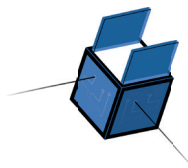

R&D, Light fittings and Electronic design department.  
A Solidworks 3D & Autocad computer infographic department.

## TESTING AND CONTROL LABORATORY



An EMC laboratory for the control and validation of products and components.  
A photogoniometer for photometric measurements. A test and endurance room.

## LIGHT FITTING MANUFACTURE



Cabling and Assembling lines.  
Mechanical area with cutting, drilling and milling equipments.  
Paint Booth.

## ELECTRONIC PRODUCTION

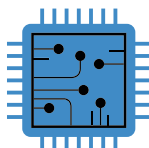

A triple head SMC Assembly line, a wave soldering line, tests and controls area.

## CUSTOMER SUPPORT



A multilingual commercial department at your disposal.  
A technical support and lighting calculation department.







# APPROACH



## IP RATINGS









1<sup>st</sup> figure:

Protection against penetration by solid objects and contact with live parts.

<b>IP 0</b> No protection 	<b>IP 1</b> Protected against solid bodies larger than 50 mm (e.g. hand contact) 	<b>IP 2</b> Protected against solid bodies larger than 12.5 mm (e.g. finger) 	<b>IP 3</b> Protected against solid bodies larger than 2.5 mm (e.g. tools, wires) 	<b>IP 4</b> Protected against solid bodies larger than 1 mm (e.g. fine tools, nails) 	<b>IP 5</b> Protected against dust 	<b>IP 6</b> Totally protected against dust 
---	--	--	---	--	--	--

2<sup>nd</sup> figure:

Protection against liquid penetration.

<b>IP 0</b> No protection 	<b>IP 1</b> Protected against vertical water drops 	<b>IP 2</b> Protected against water drops up to 15° from the vertical 	<b>IP 3</b> Protected against rain up to 60° from the vertical 	<b>IP 4</b> Protected against water splashing from any directions 	<b>IP 5</b> Protected against low-pressure water jets from any direction using a lance 	<b>IP 6</b> Protected against high-pressure water jets from any direction 
<b>IP 7</b> Protected against the effects of immersion 	<b>IP 8</b> Equipment submersible under specified conditions 					

## VK® vandal resistance rating.

The VK® rating allows better characterization of anti-vandal luminaires: it includes mechanical strength beyond IK10, as well as the other characteristics involved in vandal resistance.

VK® rating	1 <sup>st</sup> position	2 <sup>nd</sup> position	(3 <sup>rd</sup> position)
0	< 10 joules	no protection	no protection
1	10 joules (*)	standard fastenings	flame resistance
2	20 joules (*)	vandal-resistant fastenings (or secure closure)	graffiti resistance
3	50 joules (*)	rip-out resistant	increased UV resistance (tropicalization)
4	80 joules	rip-out-resistant + standard fastenings	resistance to marine environment
5	100 joules	rip-out-resistant + vandal-resistant fastenings	-
6	120 joules	anti-ligature + vandal-resistant fastenings	-
7	150 joules	-	-

## IK rating for resistance to mechanical impacts (EN 62262).

Impact resistance	Mass / Drop height
IK 1 / 0,140 joule	0,25 kg: 56 mm
IK 2 / 0,20 joule	0,25 kg: 80 mm
IK 3 / 0,35 joule	0,25 kg: 140 mm
IK 4 / 0,50 joule	0,25 kg: 200 mm
IK 5 / 0,70 joule	0,25 kg: 280 mm
IK 6 / 1 joule	0,25 kg: 400 mm
IK 7 / 2 joules	0,50 kg: 400 mm
IK 8 / 5 joules	1,70 kg: 300 mm
IK 9 / 10 joules	5 kg: 200 mm
IK 10 / 20 joules	5 kg: 400 mm
IK 11 / 50 joules	10 kg: 500 mm
IK 11+ / 80 joules	10 kg: 800 mm
IK 11++ / 100 joules	10 kg: 1000 mm
IK 11++ / 120 joules	15 kg: 800 mm
IK 11++ / 150 joules	15 kg: 1000 mm

# FEATURES



## EXPERTISES

Securlite know how at the disposal of special requests and tailored adaptations.

- IP rating IP65 - IP67
- Resistance to mechanical shocks from IK10-20 joules to IK11 \*\* 150 Joules
- Lumen maintenance: L80B10 / over 72,000 hours
- Industrial Drivers lifetime > 100,000 h
- Stroke protections
- Halogen free cabling
- Diffusers: polycarbonate, polymethacrylate, tempered glass
- Bodies: Marine grade aluminium, Electro Galvanized Steel, 304L and 316L stainless steel
- Resistant to oils and hydrocarbons
- RAL Color on demand
- Tamperproof fastening with snake eyes - torx - torx pin screws
- Integrated or remote movement sensors
- Adjustable standby lighting
- Dimming of light output
- Full range of technical optics
- Self contained emergency 1 or 3h battery
- Central emergency systems
- Integrated loud speakers
- Integrated CCTV
- Integrated communication system
- Trunking (continuous line with junction panels between light fittings)
- On demand Sizing

## FOCUS ON SENSORS

Available functionalities:

- Standard high frequency movement detection
- Remote controller detection with radio link
- Warning / standby detection
- Remote controlled warning / standby detection with radio link
- Slave control modules
- Standby consumption less than 0,5W



# SPECIFIC CHARACTERISTICS

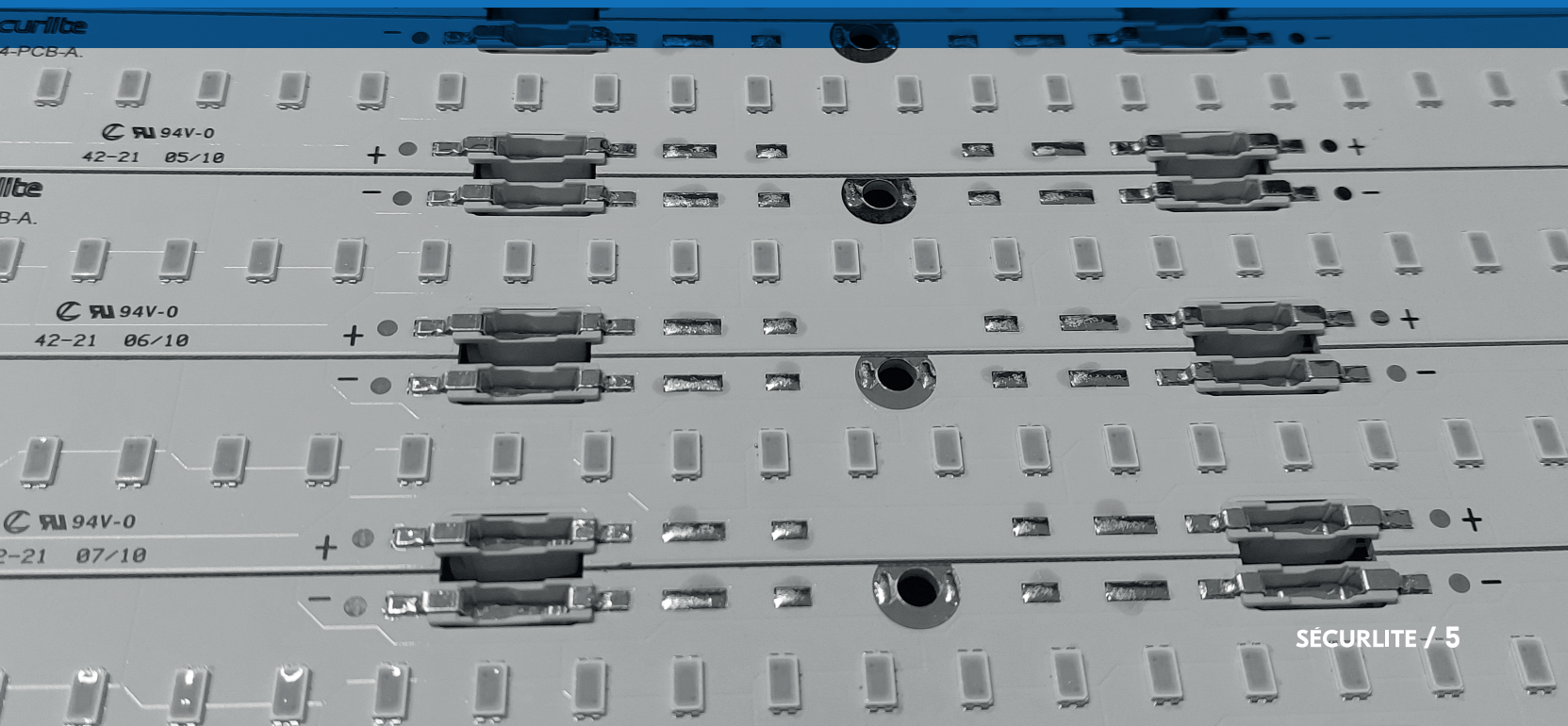

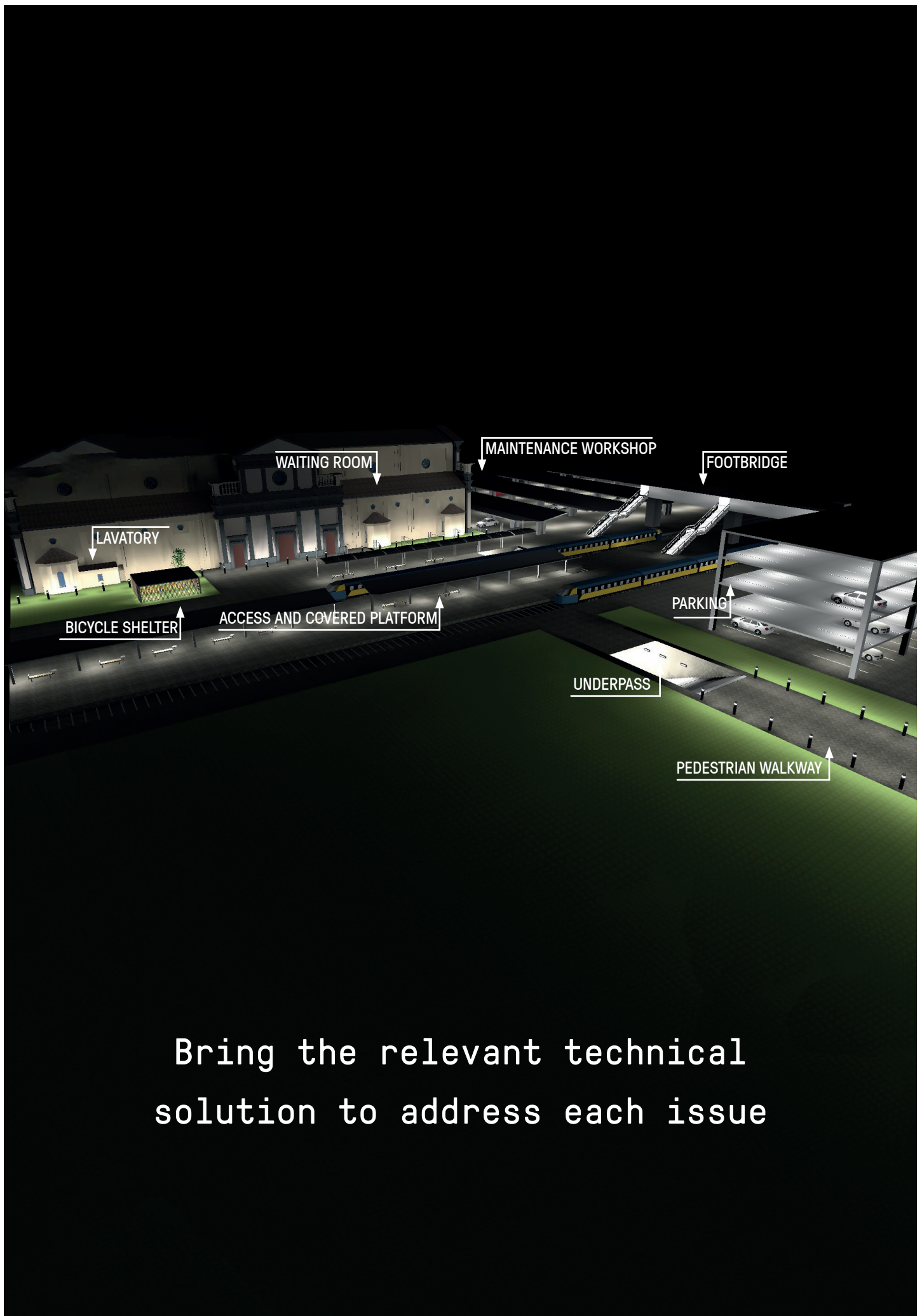

Bring the relevant technical  
solution to address each issue

## TITAN S2

**i** direct 500

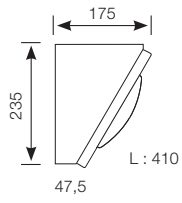

## TITAN COMPACT

**i** direct 642

**i** direct 640

**i** direct 641

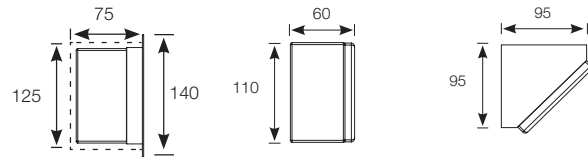

Flush mounting dimensions:  
R x 125 mm x 75 mm

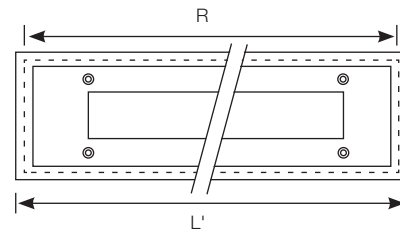

## ASL

**i** direct 515

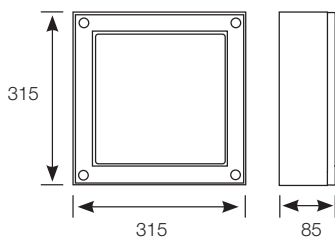

## ESL

**i** direct 517

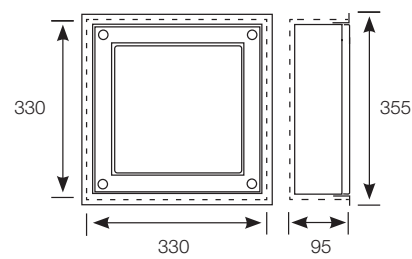

Flush mounting dimensions:  
330 mm x 330 mm x 95 mm

# PEDESTRIAN WALKWAY



Nord station - Paris

SECURLITE / 7

## FILA<sup>2</sup>

 direct 730

 direct 740

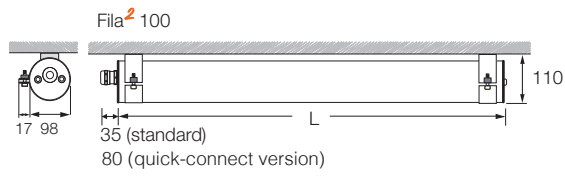
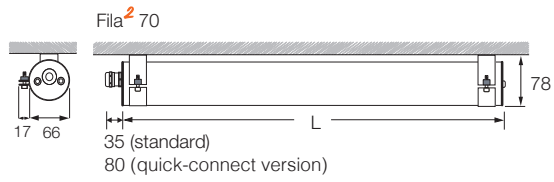

## URBALINE

 direct 650

 direct 660

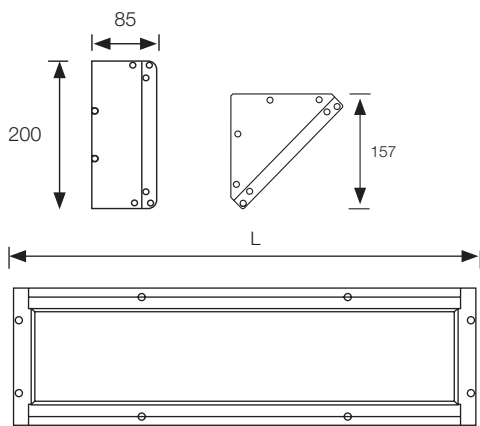

## TITAN

 direct 627

 direct 636

 direct 617

 direct 607

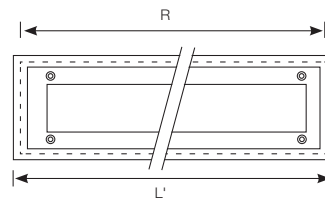
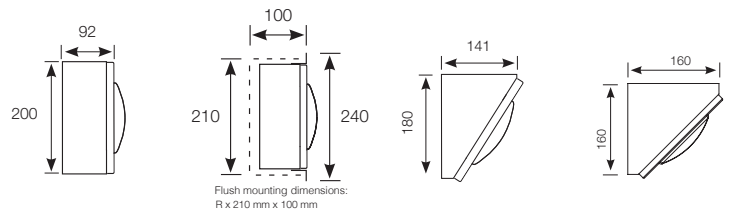

## ALEANE

 direct 691

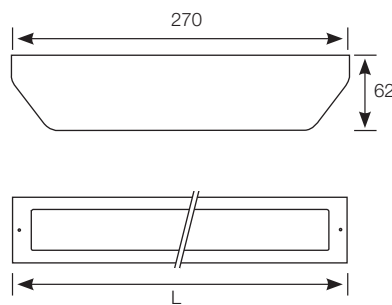

# UNDERPASS





## FILA<sup>2</sup>

 direct 730

 direct 740

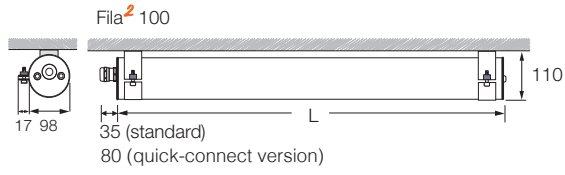
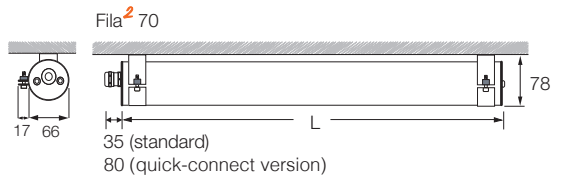

## TITAN COMPACT

 direct 642

 direct 640

 direct 641

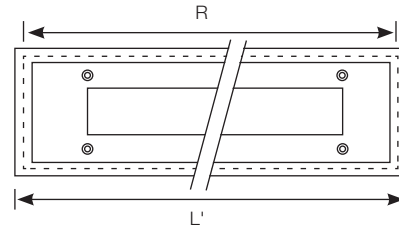
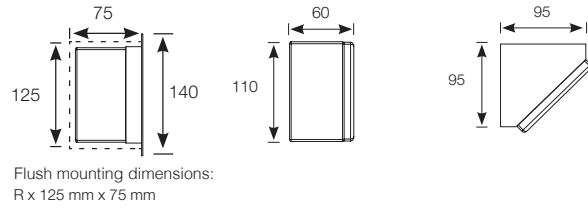

# FOOTBRIDGE

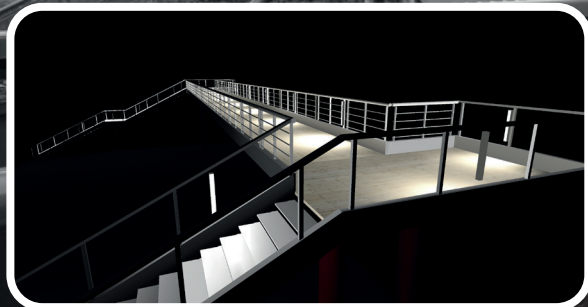

St André de Cubzac station

## FILA<sup>2</sup>

**i** direct [730](#)

**i** direct [740](#)

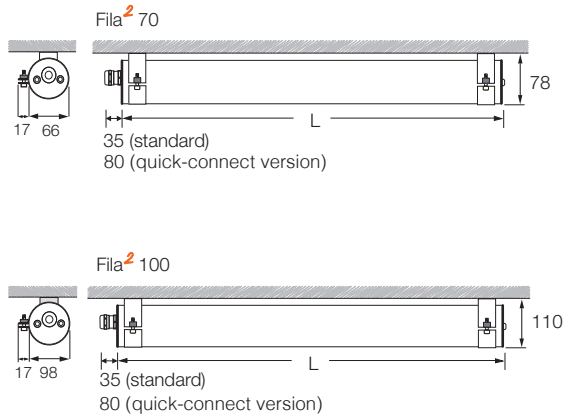

## TITAN

**i** direct [627](#)

**i** direct [636](#)

**i** direct [617](#)

**i** direct [607](#)

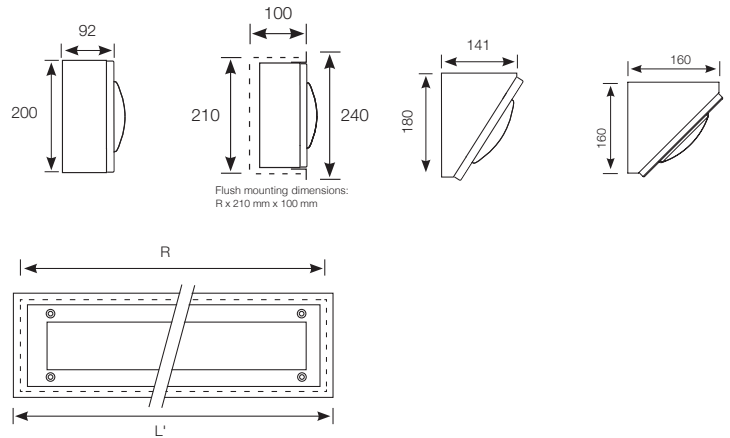

## RONDO

**i** direct [252](#)

## RONDINO

**i** direct [256](#)

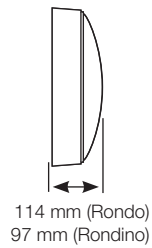
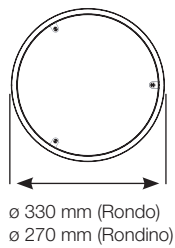

## SYSTEO

**i** direct [776](#)

**i** direct [774](#)

**i** direct [778](#)

**i** direct [772](#)

**i** direct [770](#)

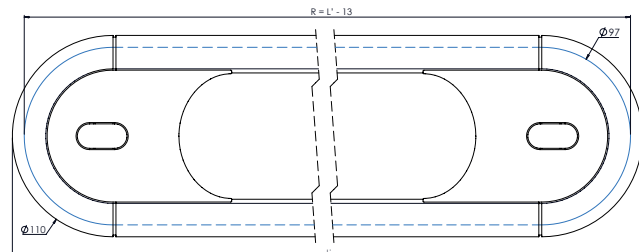

# ACCESS AND COVERED PLATFORM



## FILA<sup>2</sup>

**i** direct 730

**i** direct 740

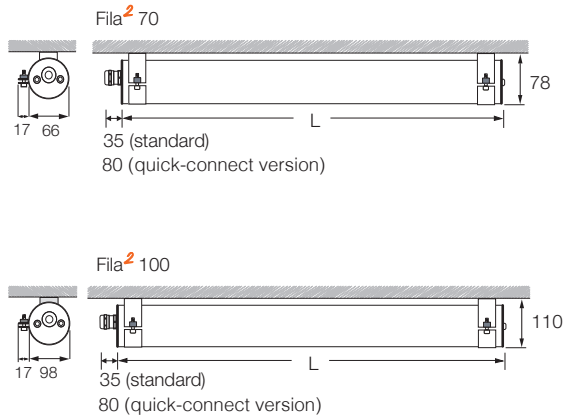

## SENSPOT

**i** direct 403

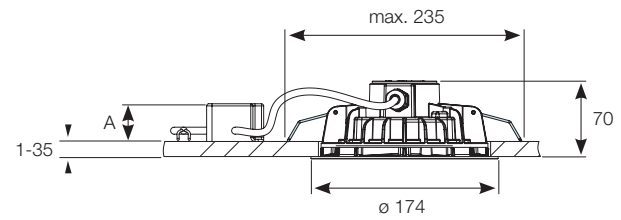

IP44 A : 33 mm  
IP65 A : 70 mm

 Flush mounting version:  
ø 160

## VOILA

**i** direct 106

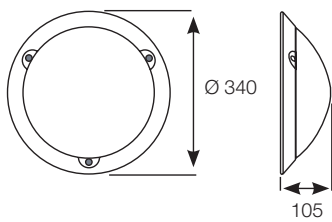

## BANG

**i** direct 156

**i** direct 166

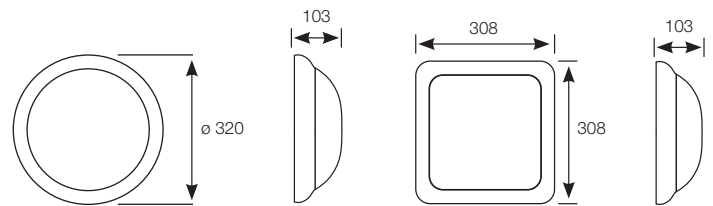

**i** direct 169

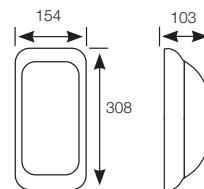

# WAITING ROOM AND SANITARY FACILITIES



## FILA<sup>2</sup>

**i** direct 730

**i** direct 740

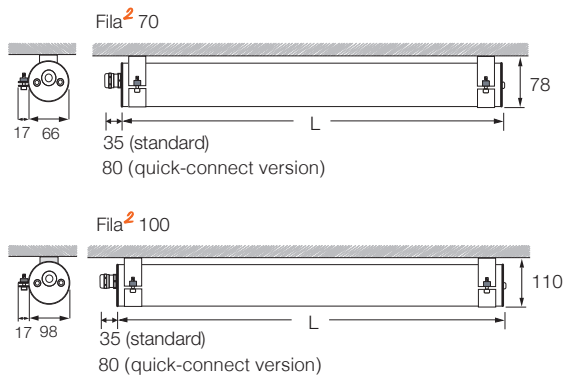

## SENSPOT

**i** direct 403

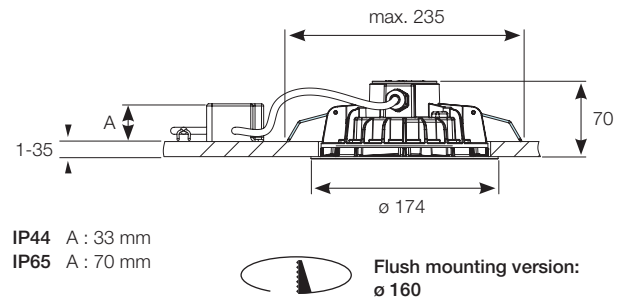

IP44 A : 33 mm  
IP65 A : 70 mm

Flush mounting version:  
ø 160

## RONDO

**i** direct 252

## RONDINO

**i** direct 256

## FILA<sup>2</sup> SIGNAGE

**i** direct 740

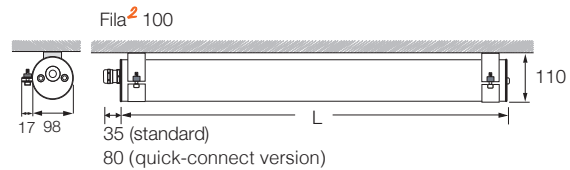
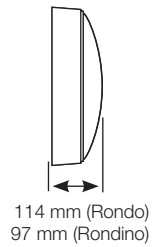
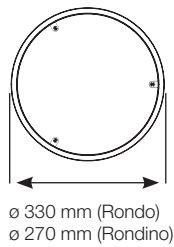

# BICYCLE PARKING SECURE SHELTERS



## FILA<sup>2</sup>

**i** direct 730

**i** direct 740

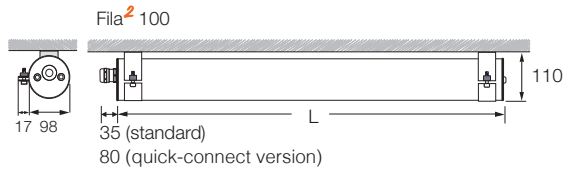
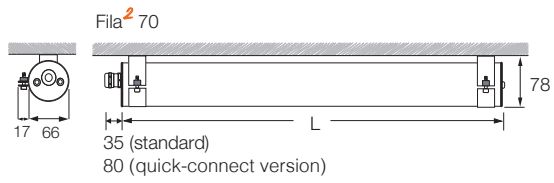

## ALEANE ASYMMETRICAL

**i** direct 694

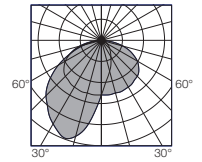
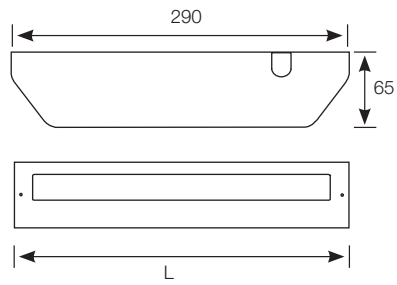

## ALEANE

**i** direct 691

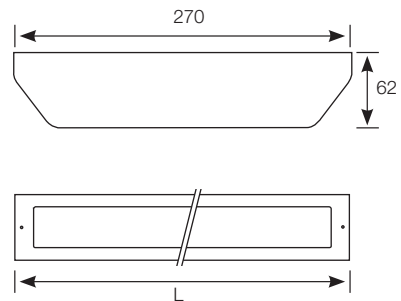

# MAINTENANCE PITS



Massena - Paris

SÉCURLITE / 13



*Maintenance pits - Paris Massena*

An offer that adapts to your specific needs



Our design office and our technical sales team provide you with specific solutions adapted to your needs, from site visits to installation assistance, including dimensioning of your product through lighting calculation.

## TAILOR MADE SUPPORT

We carry out a  
tailor made study of  
your projects

*Technical center of Calais*



**SÉCURLITE**  
DURABLE LIGHT

Z.I. DES AJEUX  
72400 LA FERTÉ-BERNARD

FRANCE

+33 2 43 60 40 00  
EXPORT@SECURLITE.COM  
WWW.SECURLITE.COM



Securlite is committed to the fight for sustainable development.

Technical and dimensional data are given for information only and may be modified at any time without notice. Please enquire before ordering.  
Terms and conditions are available at: [www.securlite.com/terms](http://www.securlite.com/terms) or upon request from our Sales Department.

Photo credits: Securlite - Antoine Duhamel Photography



Printed on PEFC paper, guaranteeing a sustainably-managed forest.  
(Program for the Endorsement of Forest Certification)